

PRATİK PANEL KALIP SİSTEMLERİ

PRATİK PANEL FORMWORK SYSTEMS

Pratik 330 Panel / Pratik 330 Panel

Ürün Kodu Product Code	Ağırlık Weight Kg	Yükseklik Height cm	Uzunluk Length cm	Çap Diameter ø mm
PK6001	407.434	330	240	-
PK6002	201.700		120	
PK6003	162.500		90	
PK6004	143.650		75	
PK6005	123.560		60	
PK6006	104.750		45	
PK6007	85.450		30	

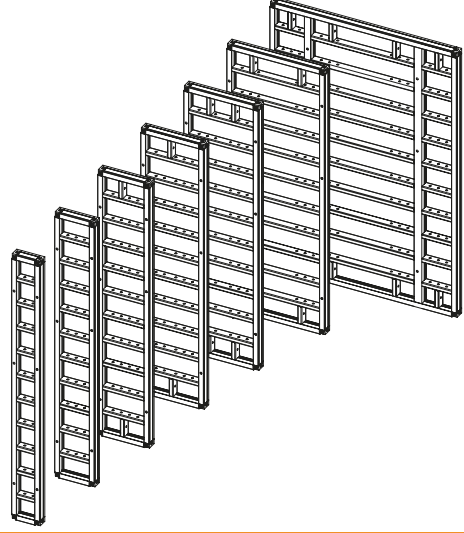

Pratik 300 Panel / Pratik 300 Panel

Ürün Kodu Product Code	Ağırlık Weight Kg	Yükseklik Height cm	Uzunluk Length cm	Çap Diameter ø mm
PK6008	372.840	300	240	-
PK6009	184.200		120	
PK6010	148.500		90	
PK6011	131.050		75	
PK6012	113.600		60	
PK6013	95.900		45	
PK6014	77.400		30	

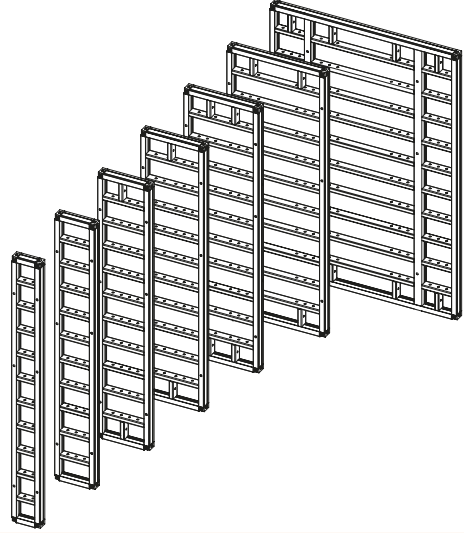

Pratik 270 Panel / Pratik 270 Panel

Ürün Kodu Product Code	Ağırlık Weight Kg	Yükseklik Height cm	Uzunluk Length cm	Çap Diameter ø mm
PK6015	336.730	270	240	-
PK6016	166.700		120	
PK6017	134.900		90	
PK6018	118.675		75	
PK6019	102.450		60	
PK6020	86.200		45	
PK6021	70.100		30	

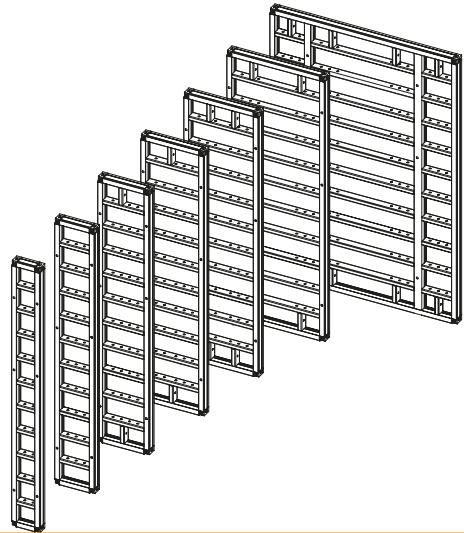

PRATİK PANEL KALIP SİSTEMLERİ

PRATİK PANEL FORMWORK SYSTEMS

Pratik 150 Panel / Pratik 150 Panel

Ürün Kodu Product Code	Ağırlık Weight Kg	Yükseklik Height cm	Uzunluk Length cm	Çap Diameter ø mm
PK6022	196.140	150	240	-
PK6023	97.200		120	
PK6024	78.200		90	
PK6025	68.500		75	
PK6026	58.900		60	
PK6027	49.200		45	
PK6028	39.450		30	

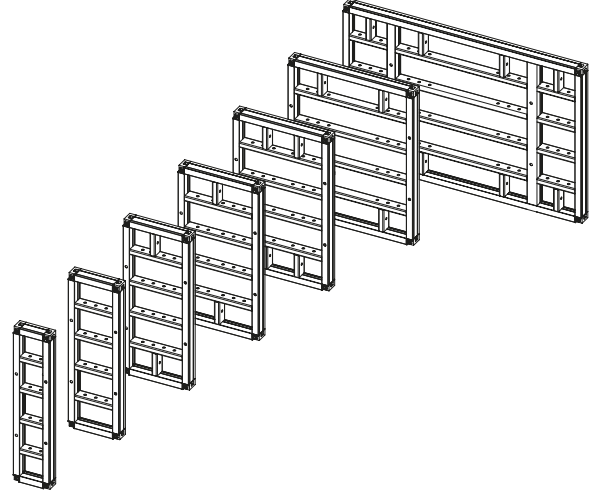

Pratik 60 Panel / Pratik 60 Panel

Ürün Kodu Product Code	Ağırlık Weight Kg	Yükseklik Height cm	Uzunluk Length cm	Çap Diameter ø mm
PK6029	92.710	60	240	-
PK6030	45.900		120	
PK6031	35.800		90	
PK6032	31.050		75	
PK6033	26.300		60	
PK6034	21.450		45	
PK6035	16.800		30	

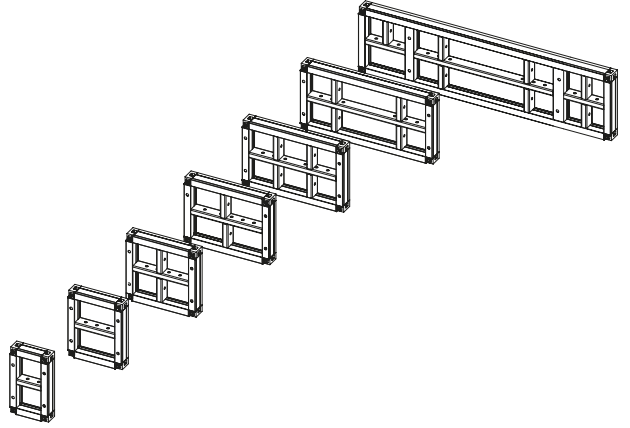

İç Köşe Panel / Internal Corner Panel

Ürün Kodu Product Code	Ağırlık Weight Kg	Yükseklik Height cm	Uzunluk Length cm	Çap Diameter ø mm
PK6036	130.500	330	-	-
PK6037	118.500	300		
PK6038	107.250	270		
PK6039	60.750	150		
PK6040	22.850	60		

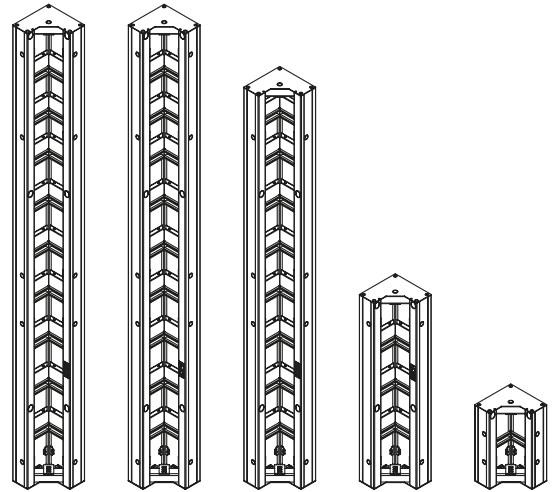

PRATİK PANEL KALIP SİSTEMLERİ

PRATİK PANEL FORMWORK SYSTEMS

Dış Köşe Panel / Outer Corner Panel

Ürün Kodu Product Code	Ağırlık Weight Kg	Yükseklik Height cm	Uzunluk Length cm	Çap Diameter ø mm
PK6041	34.500	330	-	-
PK6042	31.200	300		
PK6043	27.500	270		
PK6044	18.250	150		
PK6045	8.500	60		

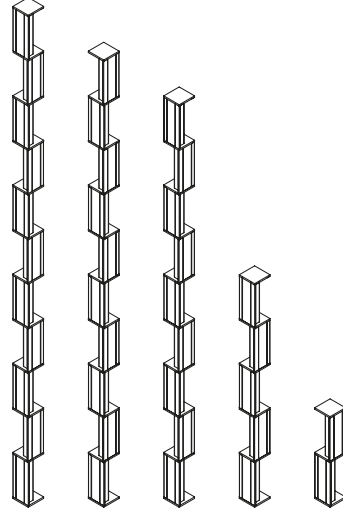

Mafsallı İç Köşe Panel / Costly Exterior Corner Panel

Ürün Kodu Product Code	Ağırlık Weight Kg	Yükseklik Height cm	Uzunluk Length cm	Çap Diameter ø mm
PK6046	105.200	330	-	-
PK6047	95.600	300		
PK6048	87.100	270		
PK6049	50.100	150		
PK6050	23.500	60		

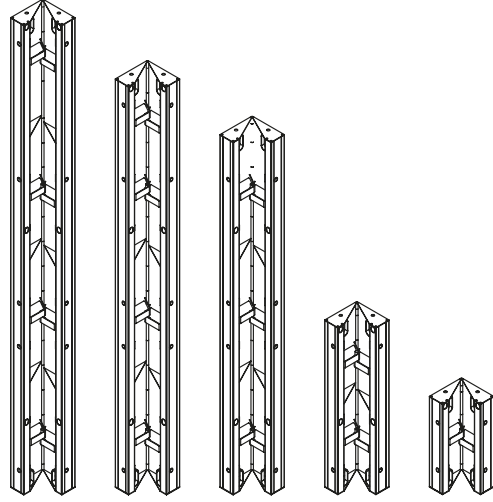

Mafsallı Dış Köşe Panel / Costly Exterior Corner Panel

Ürün Kodu Product Code	Ağırlık Weight Kg	Yükseklik Height cm	Uzunluk Length cm	Çap Diameter ø mm
PK6051	84.500	330	-	-
PK6052	77.250	300		
PK6053	69.400	270		
PK6054	41.900	150		
PK6055	19.500	60		

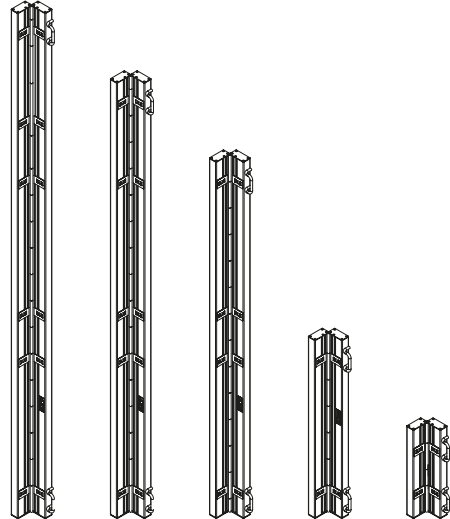

PRATİK PANEL KALIP SİSTEMLERİ

PRATİK PANEL FORMWORK SYSTEMS

Ürün Kodu Product Code	Ağırlık Weight Kg	Yükseklik Height cm	Uzunluk Length cm	Çap Diameter ø mm
PK6056	3.050	-	-	-

Panel Kiliti/ Panel Lock

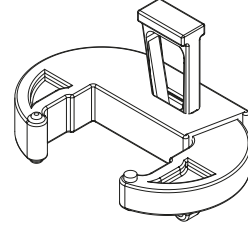

Ürün Kodu Product Code	Ağırlık Weight Kg	Yükseklik Height cm	Uzunluk Length cm	Çap Diameter ø mm
PK6057	5.450	-	-	-

Ayarlı Kilit/ Adjusted Lock

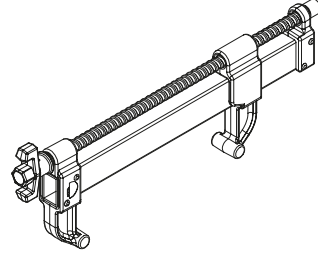

Ürün Kodu Product Code	Ağırlık Weight Kg	Yükseklik Height cm	Uzunluk Length cm	Çap Diameter ø mm
PK6058	10	-	100	-
PK6059	12	-	120	-
PK6060	15	-	150	-
PK6061	17,5	-	175	-
PK6062	20	-	200	-

Pano Kuşağı / Panel Belt

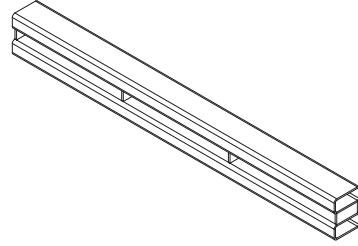

Ürün Kodu Product Code	Ağırlık Weight Kg	Yükseklik Height cm	Uzunluk Length cm	Çap Diameter ø mm
PK6063	2.10	-	-	-

Köşe Bağlantı Mili / Corner Connection Shaft

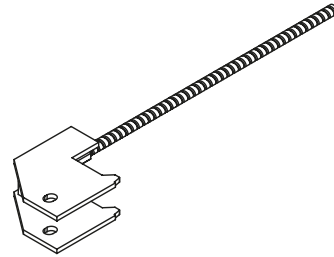

Ürün Kodu Product Code	Ağırlık Weight Kg	Yükseklik Height cm	Uzunluk Length cm	Çap Diameter ø mm
PK6064	0.550	-	-	-

Pano Çektirme Elemanı / Panel Puller Element

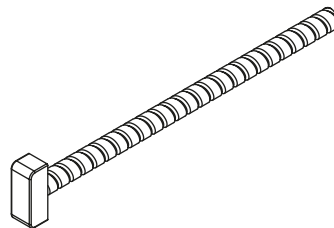

PRATİK PANEL KALIP SİSTEMLERİ

PRATİK PANEL FORMWORK SYSTEMS

Ürün Kodu Product Code	Ağırlık Weight Kg	Yükseklik Height cm	Uzunluk Length cm	Çap Diameter ø mm
PK6065	1.040	-	-	-

Kuşak Çektirme Elemanı / Belt Puller Element

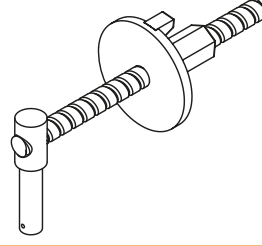

Ürün Kodu Product Code	Ağırlık Weight Kg	Yükseklik Height cm	Uzunluk Length cm	Çap Diameter ø mm
PK6066	3.050	-	-	-

Payanda Başlığı / Support Head

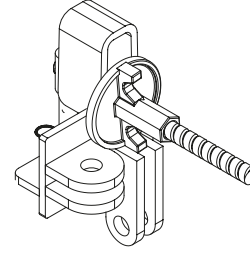

Ürün Kodu Product Code	Ağırlık Weight Kg	Yükseklik Height cm	Uzunluk Length cm	Çap Diameter ø mm
PK6067	1.250	-	-	-

Aynalı Somun Ø120 / Anchoring Plate Nut Ø120

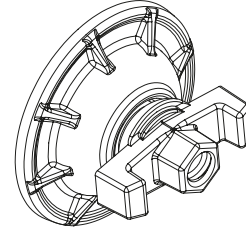

Ürün Kodu Product Code	Ağırlık Weight Kg	Yükseklik Height Min. cm	Yükseklik Height Max. cm	Çap Diameter ø mm
PK0044	23,20	165	225	-
PK0045	25,90	225	285	
PK0046	31,20	300	360	
PK0047	34,40	330	390	
PK0048	38,00	435	495	

Çift Kollu Payanda / Push Pull Prop

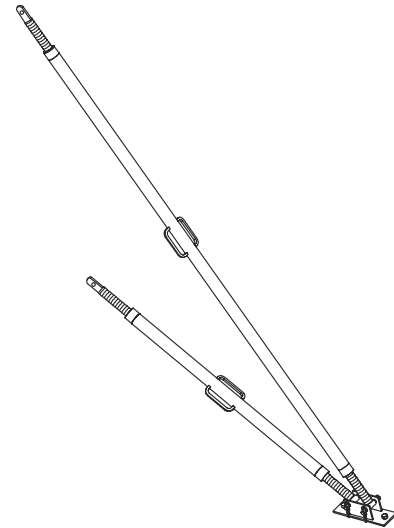

H: Kalıp Yüksekliği

6m ve üzeri yüksek perdelerde kalıbın şaküle alınması için payanda bağlantı başlığı ve payanda tabanı ile kullanılır.

6m and higher panels used with push-pull prop head and base plate.

PRATİK PANEL KALIP SİSTEMLERİ

PRATİK PANEL FORMWORK SYSTEMS

Ürün Kodu Product Code	Ağırlık Weight Kg	Yükseklik Height cm	Uzunluk Length cm	Çap Diameter ø mm
PK6058	-	-	-	-

Ürün Kodu Product Code	Ağırlık Weight Kg	Yükseklik Height cm	Uzunluk Length cm	Çap Diameter ø mm
PK0028	01,50	-	100	17
PK0029	01,90		125	
PK0030	02,30		150	
PK0031	02,60		175	
PK0032	03,00		200	
PK0033	03,40		225	
PK0034	03,80		250	
PK0035	03,00		300	

Ürün Kodu Product Code	Ağırlık Weight Kg	Yükseklik Height cm	Uzunluk Length cm	Çap Diameter ø mm
PK0036	00,50	-	-	-

Ürün Kodu Product Code	Ağırlık Weight Kg	Yükseklik Height cm	Uzunluk Length cm	Çap Diameter ø mm
PK0037	00,50	-	-	-

Ürün Kodu Product Code	Ağırlık Weight Kg	Yükseklik Height cm	Uzunluk Length cm	Çap Diameter ø mm
PK0042	00,40	-	-	-

Dairesel Kolon Modülü / Circular Column Module

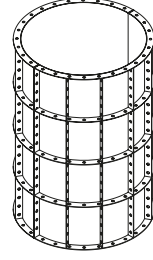

Ankraj Mili / Anchoring Bar

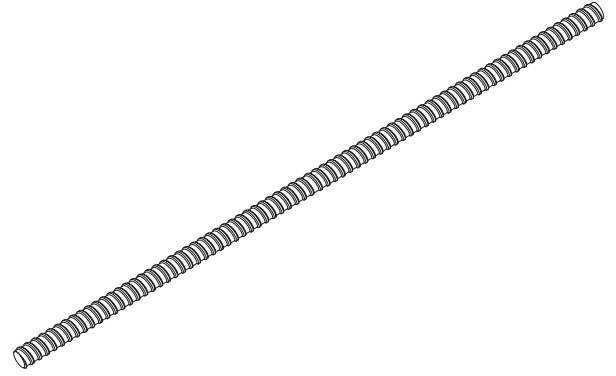

Ayna / Plate

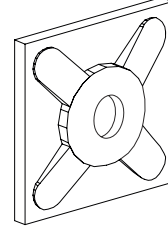

Tie Rod Somunu / Waler Wing Nut

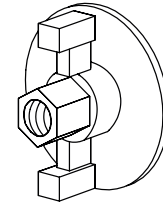

Pim / Pin

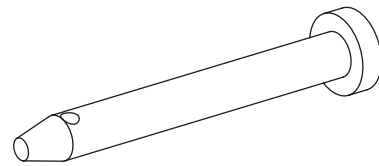

Payandaların kafalara birleşimini sağlar.
For connecting push-pull props with heads.

PRATİK PANEL KALIP SİSTEMLERİ

PRATİK PANEL FORMWORK SYSTEMS

Ürün Kodu Product Code	Ağırlık Weight Kg	Yükseklik Height cm	Uzunluk Length cm	Çap Diameter ø mm
PK0043	00,03	-	-	-

Kopilya / Cotter Pin

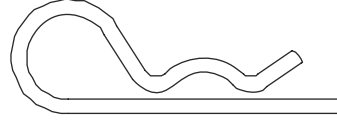

Ürün Kodu Product Code	Ağırlık Weight Kg	Yükseklik Height cm	Uzunluk Length cm	Çap Diameter ø mm
PK1120	08,20	-	-	-

Çalışma Konsolu / Walkway Bracket

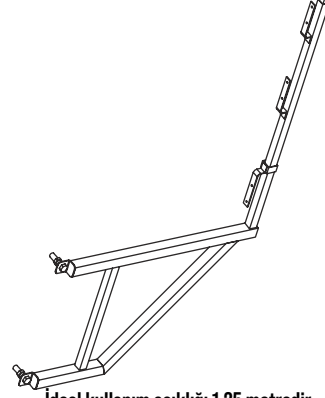

İdeal kullanım açıklığı 1,25 metredir.
Allowable spacing is 1,25 meter.

Ürün Kodu Product Code	Ağırlık Weight Kg	Yükseklik Height cm	Uzunluk Length cm	Çap Diameter ø mm
PK6059	5,200	-	-	-

Konsol Merdiveni Bağlantı Elemanı Console Ladder Connection Element

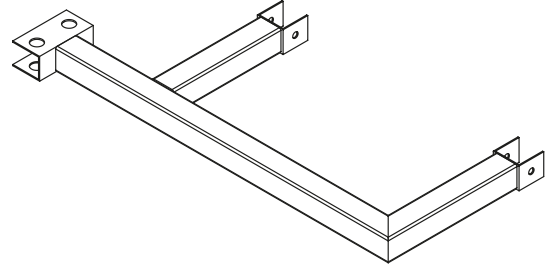

Ürün Kodu Product Code	Ağırlık Weight Kg	Yükseklik Height cm	Uzunluk Length cm	Çap Diameter ø mm
PK6060	1,120	-	-	-

Konsol Merdiveni Ekleme Elemanı Console Ladder Attachment Element

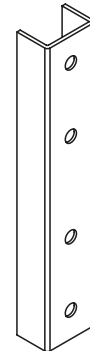

PRATİK PANEL KALIP SİSTEMLERİ

PRATİK PANEL FORMWORK SYSTEMS

Konsol Merdiveni Bitiş Elemanı Console Ladder Finishing Element

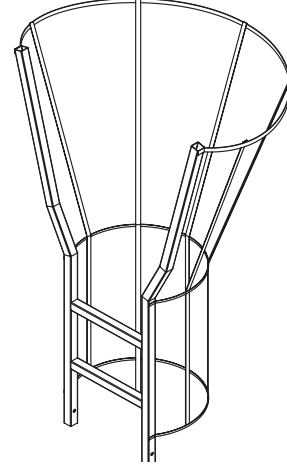

Ürün Kodu Product Code	Ağırlık Weight Kg	Yükseklik Height cm	Uzunluk Length cm	Çap Diameter ø mm
PK6061	39.400	-	-	-

Konsol Merdiveni / Console Ladder

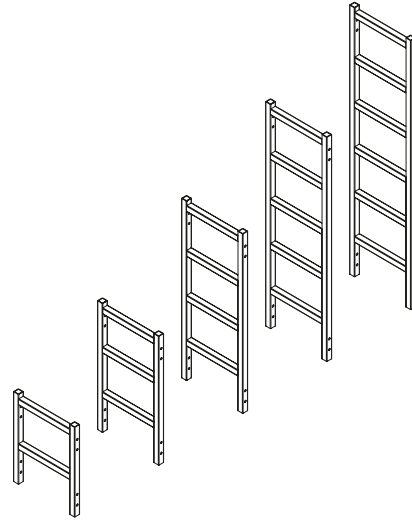

Ürün Kodu Product Code	Ağırlık Weight Kg	Yükseklik Height cm	Uzunluk Length cm	Çap Diameter ø mm
PK6062	5.200	60	-	-
PK6063	7.800	90	-	-
PK6064	10.400	120	-	-
PK6065	13.000	150	-	-
PK6066	15.600	180	-	-
PK6067	18.200	210	-	-
PK6068	20.800	240	-	-
PK6069	23.400	270	-	-
PK6070	26.000	300	-	-

Konsol Merdiveni Korkuluğu / Console Ladder Guard

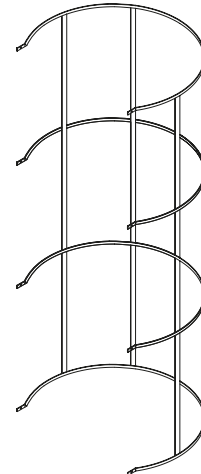

Ürün Kodu Product Code	Ağırlık Weight Kg	Yükseklik Height cm	Uzunluk Length cm	Çap Diameter ø mm
PK6071	3.650	-	-	-
PK6072	5.840	-	-	-
PK6073	8.030	-	-	-
PK6074	10.220	-	-	-